



Ekincioglu

Yangın Söndürme Sistemleri



FIRE EXTINGUISHING SYSTEMS



EK 100 SERIES - ONE DOOR FIRE CABINETS WITH SEMI-RIGID HOSE - WITHOUT FIRE EXTINGUISHER

RECESSED TYPE

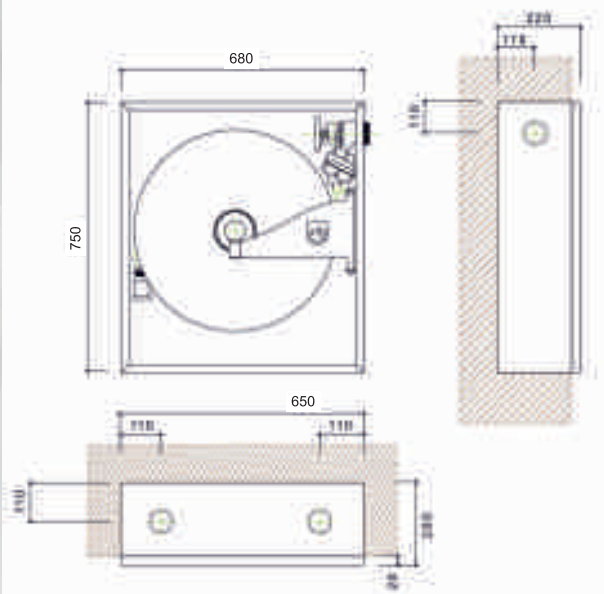

SURFACE MOUNTED TYPE

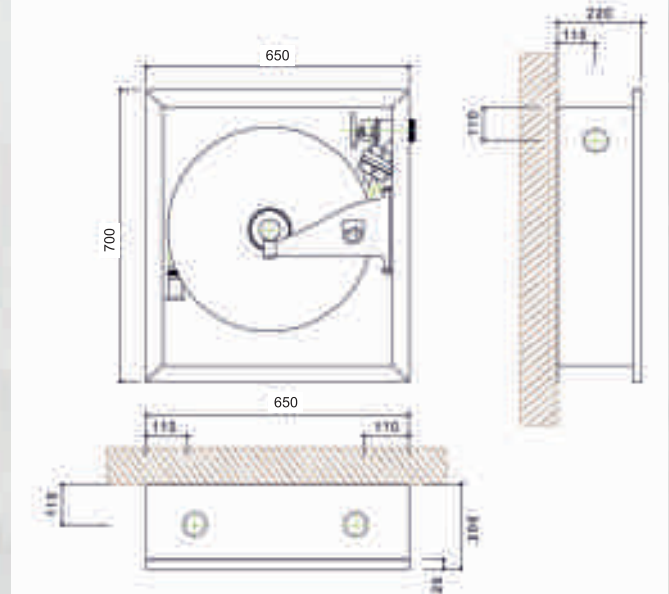

COVER OPTIONS

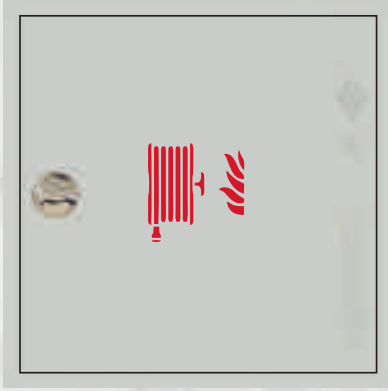

EK 100 D1 COVER

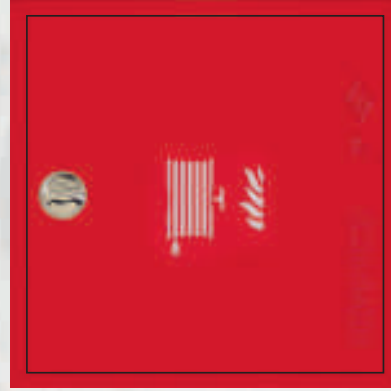

EK 100 D2 COVER



EK 100 D3 COVER

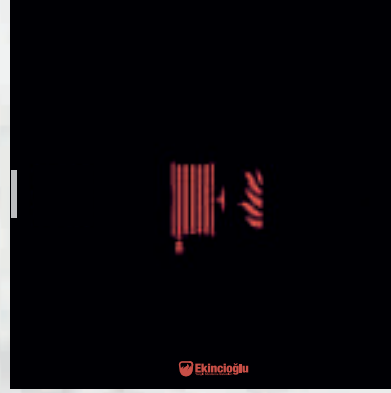

EK 100 D4 COVER

EK 100 SERIES

TECHNICAL SPECIFICATIONS

- Water Supplied from Center, Corrosion Resistant Reel, TS-EN 671-1 / CE Certified
- Semi-Hard Fire Hose with round section, TS EN 694 Certificated
- Interconnection Hose (Unbreakable Type) Providing Water Passage between Valve and Reel Center
- 2" Fire Valve
- 2" Internal Threaded Union
- 2"x 1" Reduction
- 5mm Made of Sheet Metal, Laser Cut Reel Arm (Provides 270° Reel Movement)
- With Jet, Spray and Off positions and Nozzle according to UL-FM and DIN / EN 671-1
- A1 Quality Sheet Metal Production, Reel Rim
- Reel Rim Phosphate Coating, Completely Electrostatic Powder Painted. (Red)
- Reel Arm Phosphate Coating, Completely Electrostatic Powder Painted. (Black)
- Products are shipped with cardboard packaging after tested hundred percent.
- All Hose Connections are done with Special Press Method. Clamp etc. are never used.
- All hose Connections are covered with plastic to prevent the damage to user.

DISASSEMBLED COVER- Mounted Case

- A1 Quality Sheet Metal Production, Disassembled Sheet Metal or Glass Cover
- Recessed Handle (Corrosion Resistant - Stainless)
- 180° Openable, Recessed-Hidden Hinge System (Corrosion Resistant - Stainless)
- 4mm, Smoked Color or Black Painted Tempered Glass on Glass Covers
- Warning Signs and Signs in ISO Standards on the Cover (Tear-Free and Nonfading)
- Cover Phosphate Coating with Red or White Electrostatic Powder Painted.
- * Optional Color and Design Options (Ral Codes for customer requests)
- A1 Quality Manufactured as a single piece of sheet metal, Recessed or Surface
- Breakable Valve Connection Caps on Side, Top and Back Surfaces of the Case
- Case Design Suitable for Right and Left Handed Reels
- Case Phosphate Coating with Red or White Electrostatic Powder Painted.
- Optional Color and Design Options (Ral Codes for customer requests)
- Optional, Completely Stainless CrNi Material Options are available.
- Tear-proof, Nonfading, PVC Operating Instructions are available on the Case.

TEKNİK ÖZELLİKLERİ

- Merkezinden Su Beslemeli, Korozyona Dayanıklı Makara, TS-EN 671-1/CE Belgeli
- Yuvarlak kesitli, Yarı Sert Yangın Hortumu, TS EN 694 Belgeli
- Vana ile Makara Merkezi Arasında Su Geçişini Sağlayan, Ara Bağlantı Hortumu
- 2" Yangın Vanası
- 2" İçten Dışlı Rekor
- 2" x 1" Redüksiyon
- 5mm Sacdan İmal, Lazer Kesim Makara Kolu (270°Makara Hareketi Sağlayan)
- Jet, Sprey ve Off Konumlarına Sahip UL-FM ve DIN / EN 671-1' e Uygun Nozul
- A1 Kalite Sacdan İmal, Makara Jantı
- Makara Jantı Üzeri Komple Elektrostatik Toz Boyalıdır. (Kırmızı RAL3002)
- Makara Kolu Üzeri Komple Elektrostatik Toz Boyalıdır. (KIRMIZI RAL3002)
- Ürünler Yüzde Yüz Test Edildikten Sonra Karton Ambalaj ile Sevk Edilmektedir.
- Tüm Hortum Bağlantıları Özel Pres Baskı Yöntemi ile Yapılır. Asla Kelepçe vb. Kullanılmaz.
- Tüm Hortum Bağlantıları Plastik ile Kaplanarak Kullanıcıya Zarar Vermesi Önlenmiştir.

KAPAK- KASA ÖZELLİKLERİ

- A1 Kalite Sacdan İmal, Sac veya Cam Kapak
- Gömme Kulüp (Paslanmaz)
- 180° Açılır, Gömme-Gizli Menteşe Sistemi (Paslanmaz)
- Cam Kapaklarda 4mm, Füme Renkli veya Siyah Boyalı Temperli Cam
- Kapak Üzerinde ISO Standartlarında Uyuncu Yazı ve İşaretler
- Kapak Üzeri Kırmızı veya Beyaz Elektrostatik Toz Boyalıdır.
- Opsiyonel Renk ve Tasarım Seçenekleri (Müşteri İsteklerine uygun Ral Kodlarında)
- A1 Kalite Sacdan Tek Parça Olarak İmal, Gömme veya Sivaüstü Kasa
- Kasanın Yan, Üst ve Arka Yüzeylerinde Kırılabilir Vana Bağlantı Kapakları
- Sağ ve Sol Kullanımlı Makaralara Uygun Kasa Tasarımı
- Kasa Üzeri Kırmızı veya Beyaz Elektrostatik Toz Boyalıdır.
- Opsiyonel Renk ve Tasarım Seçenekleri (Müşteri İsteklerine Uygun Ral Kodlarında)
- Opsiyonel Komple Paslanmaz CrNi Malzeme Seçenekleri Bulunmaktadır.
- Kasa Üzerinde Pvc Malzemeden İmal, Yırtılmaz Kullanma Talimatı Bulunmaktadır.





**EK 200 SERIES DOUBLE DOOR FIRE CABINETS WITH SEMI-RIGID HOSE
WITH FIRE EXTINGUISHER HELD UPRIGHT**

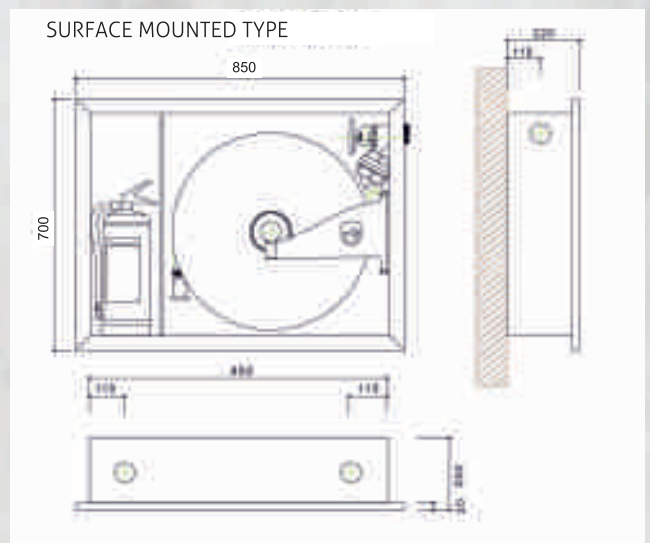
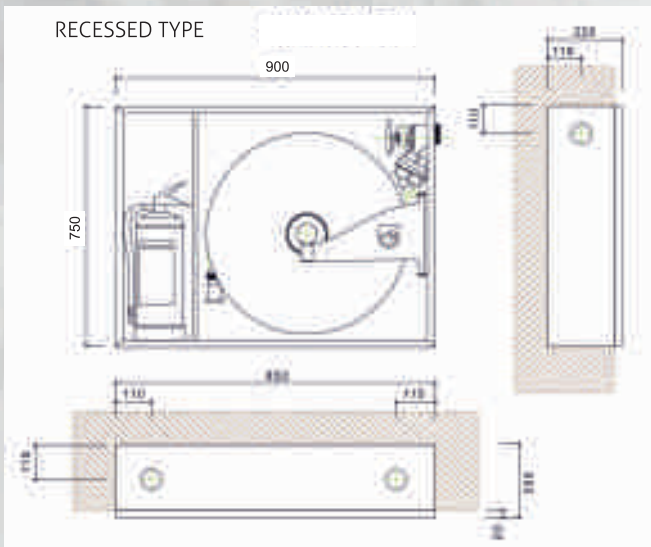

COVER OPTIONS

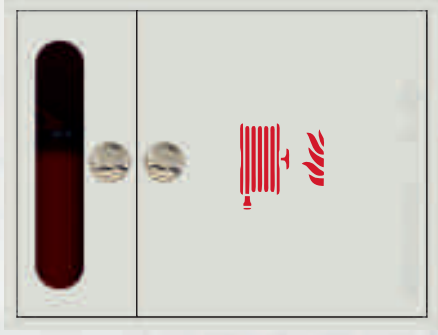

EK 200 D1 COVER

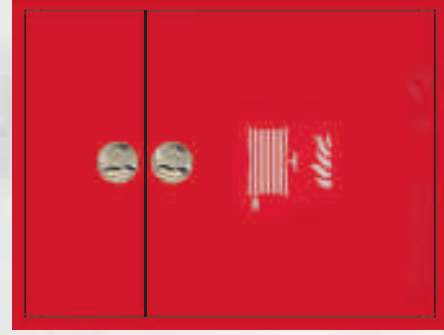

EK 200 D2 COVER

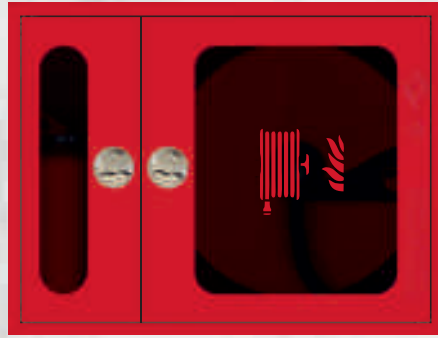

EK 200 D3 COVER

EK 200 SERIES

TECHNICAL SPECIFICATIONS

- Water Supplied from Center, Corrosion Resistant Reel, TS-EN 671-1 / CE Certified
- Semi-Hard Fire Hose with round section, TS EN 694 Certificated
- Interconnection Hose (Unbreakable Type) Providing Water Passage between Valve and Reel Center
- 2" Fire Valve
- 2" Internal Threaded Union
- 2"x 1" Reduction
- 5mm Made of Sheet Metal, Laser Cut Reel Arm (Provides 270° Reel Movement)
- With Jet, Spray and Off positions and Nozzle according to UL-FM and DIN / EN 671-1
- A1 Quality Sheet Metal Production, Reel Rim
- Reel Rim Phosphate Coating, Completely Electrostatic Powder Painted. (Red)
- Reel Arm Phosphate Coating, Completely Electrostatic Powder Painted. (Black)
- Products are shipped with cardboard packaging after tested hundred percent.
- All Hose Connections are done with Special Press Method. Clamp etc. are never used.
- All hose Connections are covered with plastic to prevent the damage to user.

DISASSEMBLED COVER- Mounted Case

- A1 Quality Sheet Metal Production, Disassembled Sheet Metal or Glass Cover
- Recessed Handle (Corrosion Resistant - Stainless)
- 180° Openable, Recessed-Hidden Hinge System (Corrosion Resistant - Stainless)
- 4mm, Smoked Color or Black Painted Tempered Glass on Glass Covers
- Warning Signs and Signs in ISO Standards on the Cover (Tear-Free and Nonfading)
- Cover Phosphate Coating with Red or White Electrostatic Powder Painted.
- * Optional Color and Design Options (Ral Codes for customer requests)
- A1 Quality Manufactured as a single piece of sheet metal, Recessed or Surface
- Breakable Valve Connection Caps on Side, Top and Back Surfaces of the Case
- Case Design Suitable for Right and Left Handed Reels
- Case Phosphate Coating with Red or White Electrostatic Powder Painted.
- Optional Color and Design Options (Ral Codes for customer requests)
- Optional, Completely Stainless CrNi Material Options are available.
- Tear-proof, Nonfading, PVC Operating Instructions are available on the Case.

TEKNİK ÖZELLİKLERİ

- Merkezinden Su Beslemeli, Korozyona Dayanıklı Makara, TS-EN 671-1/CE Belgeli
- Yuvarlak kesitli, Yarı Sert Yangın Hortumu, TS EN 694 Belgeli
- Vana ile Makara Merkezi Arasında Su Geçişini Sağlayan, Ara Bağlantı Hortumu
- 2" Yangın Vanası
- 2" İçten Dişli Rekor
- 2" x 1" Redüksiyon
- 5mm Sacdan İmal, Lazer Kesim Makara Kolu (270°Makara Hareketi Sağlayan)
- Jet, Sprey ve Off Konumlarına Sahip UL-FM ve DIN / EN 671-1'e Uygun Nozul
- A1 Kalite Sacdan İmal, Makara Jantı
- Makara Jantı Üzeri Komple Elektrostatik Toz Boyalıdır. (Kırmızı RAL3002)
- Makara Kolu Üzeri Komple Elektrostatik Toz Boyalıdır. (KIRMIZI RAL3002)
- Ürünler Yüzde Yüz Test Edildikten Sonra Karton Ambalaj ile Sevk Edilmektedir.
- Tüm Hortum Bağlantıları Özel Pres Baskı Yöntemi ile Yapılır. Asla Kelepçe vb. Kullanılmaz.
- Tüm Hortum Bağlantıları Plastik ile Kaplanarak Kullanıcıya Zarar Vermesi Önlenmiştir.

KAPAK- KASA ÖZELLİKLERİ

- A1 Kalite Sacdan İmal, Sac veya Cam Kapak
- Gömme Kulüp (Paslanmaz)
- 180° Açılır, Gömme-Gizli Menteşe Sistemi (Paslanmaz)
- Cam Kapaklarda 4mm, Füme Renkli veya Siyah Boyalı Temperli Cam
- Kapak Üzerinde ISO Standartlarında Uyuncu Yazı ve İşaretler
- Kapak Üzeri Kırmızı veya Beyaz Elektrostatik Toz Boyalıdır.
- Opsiyonel Renk ve Tasarım Seçenekleri (Müşteri İsteklerine uygun Ral Kodlarında)
- A1 Kalite Sacdan Tek Parça Olarak İmal, Gömme veya Sivaüstü Kasa
- Kasanın Yan, Üst ve Arka Yüzeylerinde Kırılabilir Vana Bağlantı Kapakları
- Sağ ve Sol Kullanımlı Makaralara Uygun Kasa Tasarımı
- Kasa Üzeri Kırmızı veya Beyaz Elektrostatik Toz Boyalıdır.
- Opsiyonel Renk ve Tasarım Seçenekleri (Müşteri İsteklerine Uygun Ral Kodlarında)
- Opsiyonel Komple Paslanmaz CrNi Malzeme Seçenekleri Bulunmaktadır.
- Kasa Üzerinde Pvc Malzemeden İmal, Yırtılmaz Kullanma Talimatı Bulunmaktadır.



COVER OPTIONS



EK 300 D1 COVER

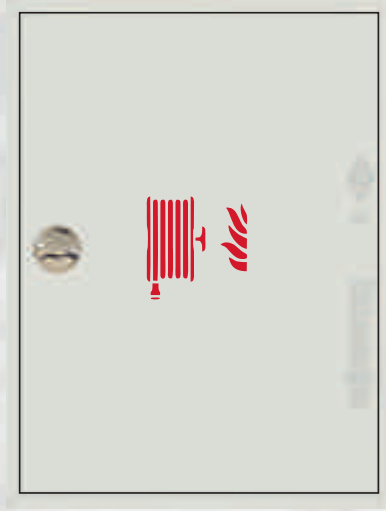

EK 300 D2 COVER

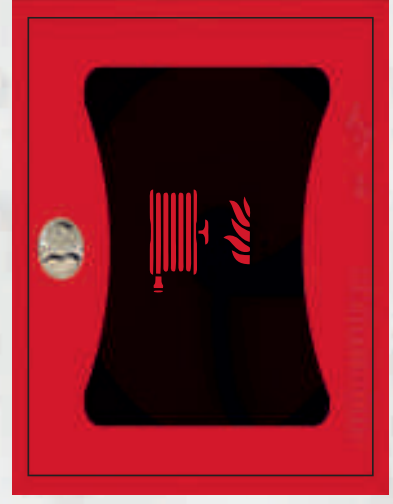

EK 300 D3 COVER

EK 300 SERIES

TECHNICAL SPECIFICATIONS

- Water Supplied from Center, Corrosion Resistant Reel, TS-EN 671-1 / CE Certified
- Semi-Hard Fire Hose with round section, TS EN 694 Certificated
- Interconnection Hose (Unbreakable Type) Providing Water Passage between Valve and Reel Center
- 2" Fire Valve
- 2" Internal Threaded Union
- 2"x 1" Reduction
- 5mm Made of Sheet Metal, Laser Cut Reel Arm (Provides 270° Reel Movement)
- With Jet, Spray and Off positions and Nozzle according to UL-FM and DIN / EN 671-1
- A1 Quality Sheet Metal Production, Reel Rim
- Reel Rim Phosphate Coating, Completely Electrostatic Powder Painted. (Red)
- Reel Arm Phosphate Coating, Completely Electrostatic Powder Painted. (Black)
- Products are shipped with cardboard packaging after tested hundred percent.
- All Hose Connections are done with Special Press Method. Clamp etc. are never used.
- All hose Connections are covered with plastic to prevent the damage to user.

DISASSEMBLED COVER- Mounted Case

- A1 Quality Sheet Metal Production, Disassembled Sheet Metal or Glass Cover
- Recessed Handle (Corrosion Resistant - Stainless)
- 180° Openable, Recessed-Hidden Hinge System (Corrosion Resistant - Stainless)
- 4mm, Smoked Color or Black Painted Tempered Glass on Glass Covers
- Warning Signs and Signs in ISO Standards on the Cover (Tear-Free and Nonfading)
- Cover Phosphate Coating with Red or White Electrostatic Powder Painted.
- * Optional Color and Design Options (Ral Codes for customer requests)
- A1 Quality Manufactured as a single piece of sheet metal, Recessed or Surface
- Breakable Valve Connection Caps on Side, Top and Back Surfaces of the Case
- Case Design Suitable for Right and Left Handed Reels
- Case Phosphate Coating with Red or White Electrostatic Powder Painted.
- Optional Color and Design Options (Ral Codes for customer requests)
- Optional, Completely Stainless CrNi Material Options are available.
- Tear-proof, Nonfading, PVC Operating Instructions are available on the Case.

TEKNİK ÖZELLİKLERİ

- Merkezinden Su Beslemeli, Korozyona Dayanıklı Makara, TS-EN 671-1/CE Belgeli
- Yuvarlak kesitli, Yarı Sert Yangın Hortumu, TS EN 694 Belgeli
- Vana ile Makara Merkezi Arasında Su Geçişini Sağlayan, Ara Bağlantı Hortumu
- 2" Yangın Vanası
- 2" İçten Dişli Rekor
- 2" x 1" Redüksiyon
- 5mm Sacdan İmal, Lazer Kesim Makara Kolu (270°Makara Hareketi Sağlayan)
- Jet, Sprey ve Off Konumlarına Sahip UL-FM ve DIN / EN 671-1'e Uygun Nozul
- A1 Kalite Sacdan İmal, Makara Jantı
- Makara Jantı Üzeri Komple Elektrostatik Toz Boyalıdır. (Kırmızı RAL3002)
- Makara Kolu Üzeri Komple Elektrostatik Toz Boyalıdır. (KIRMIZI RAL3002)
- Ürünler Yüzde Yüz Test Edildikten Sonra Karton Ambalaj ile Sevk Edilmektedir.
- Tüm Hortum Bağlantıları Özel Pres Baskı Yöntemi ile Yapılır. Asla Kelepçe vb. Kullanılmaz.
- Tüm Hortum Bağlantıları Plastik ile Kaplanarak Kullanıcıya Zarar Vermesi Önlenmiştir.

KAPAK- KASA ÖZELLİKLERİ

- A1 Kalite Sacdan İmal, Sac veya Cam Kapak
- Gömme Kulüp (Paslanmaz)
- 180° Açılır, Gömme-Gizli Menteşe Sistemi (Paslanmaz)
- Cam Kapaklarda 4mm, Füme Renkli veya Siyah Boyalı Temperli Cam
- Kapak Üzerinde ISO Standartlarında Uyuncu Yazı ve İşaretler
- Kapak Üzeri Kırmızı veya Beyaz Elektrostatik Toz Boyalıdır.
- Opsiyonel Renk ve Tasarım Seçenekleri (Müşteri İsteklerine uygun Ral Kodlarında)
- A1 Kalite Sacdan Tek Parça Olarak İmal, Gömme veya Sivaüstü Kasa
- Kasanın Yan, Üst ve Arka Yüzeylerinde Kırılabilir Vana Bağlantı Kapakları
- Sağ ve Sol Kullanımlı Makaralara Uygun Kasa Tasarımı
- Kasa Üzeri Kırmızı veya Beyaz Elektrostatik Toz Boyalıdır.
- Opsiyonel Renk ve Tasarım Seçenekleri (Müşteri İsteklerine Uygun Ral Kodlarında)
- Opsiyonel Komple Paslanmaz CrNi Malzeme Seçenekleri Bulunmaktadır.
- Kasa Üzerinde Pvc Malzemeden İmal, Yırtılmaz Kullanma Talimatı Bulunmaktadır.





EK 320 SERIES ONE DOOR FIRE CABINETS WITH SEMI RIGID HOSE - WITH FIRE EXTINGUISHER HELD VERTICAL

RECESSED TYPE

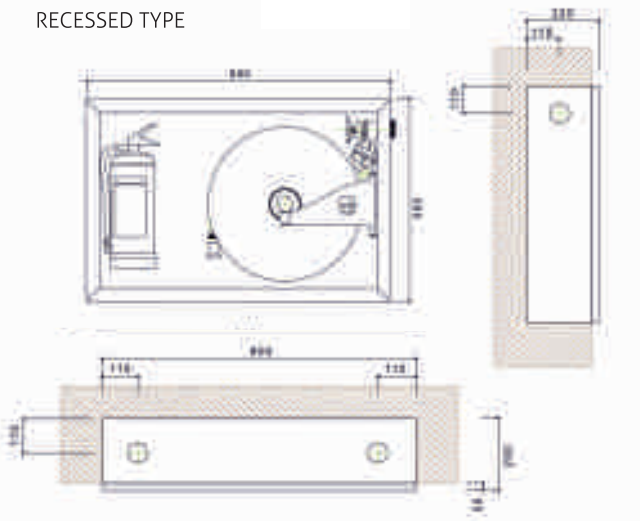

SURFACE MOUNTED TYPE

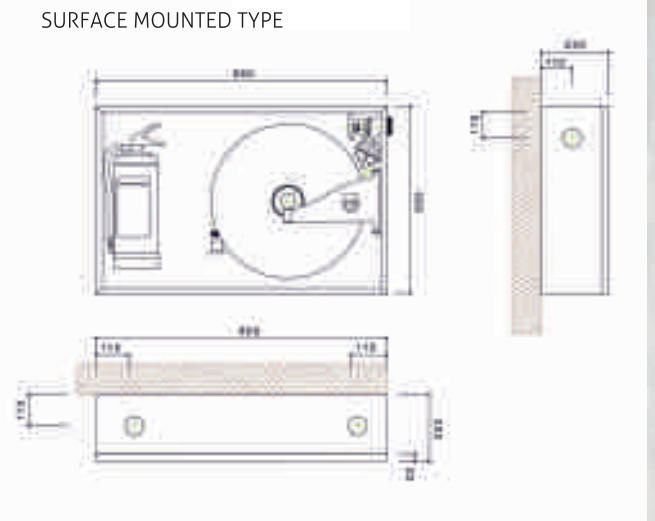

COVER OPTIONS

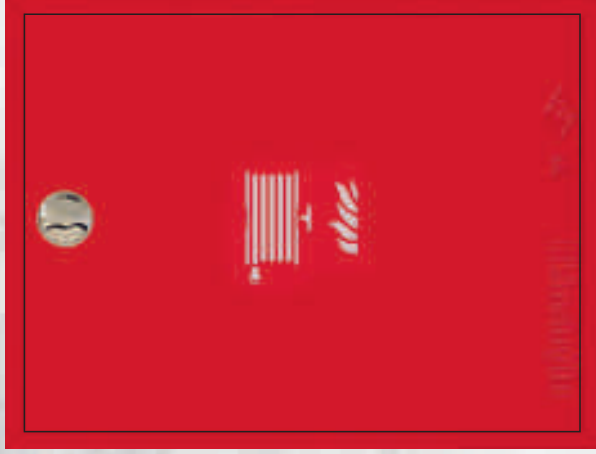

EK 320 D3 COVER

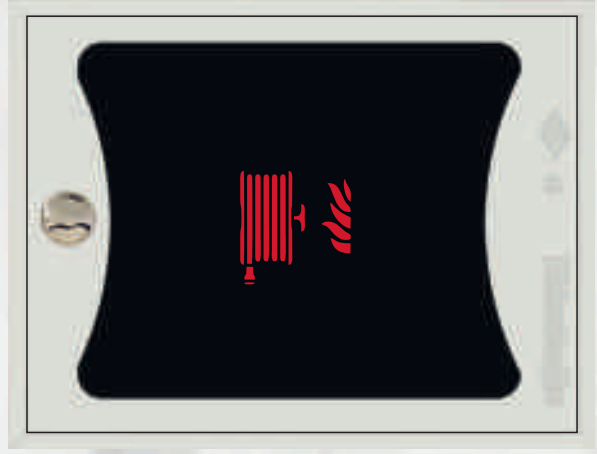

EK 320 D2 COVER

EK 320 SERIES

TECHNICAL SPECIFICATIONS

- Water Supplied from Center, Corrosion Resistant Reel, TS-EN 671-1 / CE Certified
- Semi-Hard Fire Hose with round section, TS EN 694 Certificated
- Interconnection Hose (Unbreakable Type) Providing Water Passage between Valve and Reel Center
- 2" Fire Valve
- 2" Internal Threaded Union
- 2"x 1" Reduction
- 5mm Made of Sheet Metal, Laser Cut Reel Arm (Provides 270° Reel Movement)
- With Jet, Spray and Off positions and Nozzle according to UL-FM and DIN / EN 671-1
- A1 Quality Sheet Metal Production, Reel Rim
- Reel Rim Phosphate Coating, Completely Electrostatic Powder Painted. (Red)
- Reel Arm Phosphate Coating, Completely Electrostatic Powder Painted. (Black)
- Products are shipped with cardboard packaging after tested hundred percent.
- All Hose Connections are done with Special Press Method. Clamp etc. are never used.
- All hose Connections are covered with plastic to prevent the damage to user.

DISASSEMBLED COVER- Mounted Case

- A1 Quality Sheet Metal Production, Disassembled Sheet Metal or Glass Cover
- Recessed Handle (Corrosion Resistant - Stainless)
- 180° Openable, Recessed-Hidden Hinge System (Corrosion Resistant - Stainless)
- 4mm, Smoked Color or Black Painted Tempered Glass on Glass Covers
- Warning Signs and Signs in ISO Standards on the Cover (Tear-Free and Nonfading)
- Cover Phosphate Coating with Red or White Electrostatic Powder Painted.
- * Optional Color and Design Options (Ral Codes for customer requests)
- A1 Quality Manufactured as a single piece of sheet metal, Recessed or Surface
- Breakable Valve Connection Caps on Side, Top and Back Surfaces of the Case
- Case Design Suitable for Right and Left Handed Reels
- Case Phosphate Coating with Red or White Electrostatic Powder Painted.
- Optional Color and Design Options (Ral Codes for customer requests)
- Optional, Completely Stainless CrNi Material Options are available.
- Tear-proof, Nonfading, PVC Operating Instructions are available on the Case.

TEKNİK ÖZELLİKLERİ

- Merkezinden Su Beslemeli, Korozyona Dayanıklı Makara, TS-EN 671-1/CE Belgeli
- Yuvarlak kesitli, Yarı Sert Yangın Hortumu, TS EN 694 Belgeli
- Vana ile Makara Merkezi Arasında Su Geçişini Sağlayan, Ara Bağlantı Hortumu
- 2" Yangın Vanası
- 2" İçten Dişli Rekor
- 2" x 1" Redüksiyon
- 5mm Sacdan İmal, Lazer Kesim Makara Kolu (270°Makara Hareketi Sağlayan)
- Jet, Sprey ve Off Konumlarına Sahip UL-FM ve DIN / EN 671-1'e Uygun Nozul
- A1 Kalite Sacdan İmal, Makara Jantı
- Makara Jantı Üzeri Komple Elektrostatik Toz Boyalıdır. (Kırmızı RAL3002)
- Makara Kolu Üzeri Komple Elektrostatik Toz Boyalıdır. (KIRMIZI RAL3002)
- Ürünler Yüzde Yüz Test Edildikten Sonra Karton Ambalaj ile Sevk Edilmektedir.
- Tüm Hortum Bağlantıları Özel Pres Baskı Yöntemi ile Yapılır. Asla Kelepçe vb. Kullanılmaz.
- Tüm Hortum Bağlantıları Plastik ile Kaplanarak Kullanıcıya Zarar Vermesi Önlenmiştir.

KAPAK- KASA ÖZELLİKLERİ

- A1 Kalite Sacdan İmal, Sac veya Cam Kapak
- Gömme Kulüp (Paslanmaz)
- 180° Açılır, Gömme-Gizli Menteşe Sistemi (Paslanmaz)
- Cam Kapaklarda 4mm, Füme Renkli veya Siyah Boyalı Temperli Cam
- Kapak Üzerinde ISO Standartlarında Uyuncu Yazı ve İşaretler
- Kapak Üzeri Kırmızı veya Beyaz Elektrostatik Toz Boyalıdır.
- Opsiyonel Renk ve Tasarım Seçenekleri (Müşteri İsteklerine uygun Ral Kodlarında)
- A1 Kalite Sacdan Tek Parça Olarak İmal, Gömme veya Sıvaüstü Kasa
- Kasanın Yan, Üst ve Arka Yüzeylerinde Kırılabilir Vana Bağlantı Kapakları
- Sağ ve Sol Kullanımlı Makaralara Uygun Kasa Tasarımı
- Kasa Üzeri Kırmızı veya Beyaz Elektrostatik Toz Boyalıdır.
- Opsiyonel Renk ve Tasarım Seçenekleri (Müşteri İsteklerine Uygun Ral Kodlarında)
- Opsiyonel Komple Paslanmaz CrNi Malzeme Seçenekleri Bulunmaktadır.
- Kasa Üzerinde Pvc Malzemeden İmal, Yırtılmaz Kullanma Talimatı Bulunmaktadır.



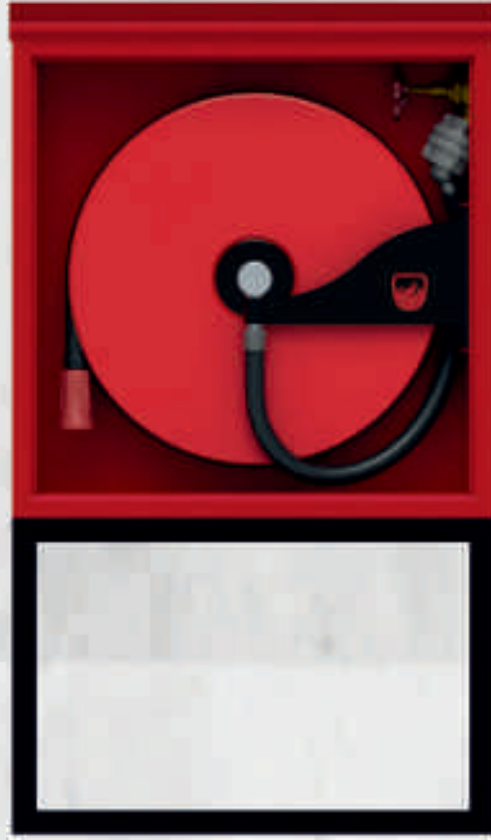

EK 500 SERIES FIRE HYDRANT CABINETS WITH SEMI-RIGID HOSE WITH 1 SET OF ACCESSORIES

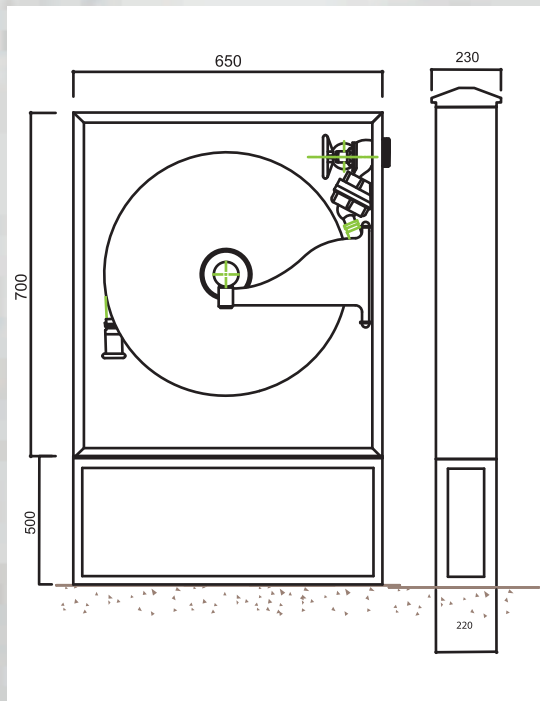

COVER OPTIONS



EK 500 SERIES

INTERNAL MATERIALS DISASSEMBLED COVER

- Water Supplied from Center, Corrosion Resistant Reel, TS-EN 671-1 / CE Certified
- Semi-Hard Fire Hose with round section, TS EN 694 Certificated
- Interconnection Hose (Unbreakable Type) Providing Water Passage between Valve and Reel Center
- 2" Fire Valve optional
- 2" Internal Threaded Union (Aluminum - Storz Type)
- 2"x 1" Reduction (Aluminum - Storz Type)
- 5mm Made of Sheet Metal, Laser Cut Reel Arm (Provides 270° Reel Movement)
- With Jet, Spray and Off positions and Nozzle according to UL-FM and DIN / EN 671-1
- A1 Quality Sheet Metal Production, Reel Rim
- Reel Rim Phosphate Coating, Completely Electrostatic Powder Painted, (Red)
- Reel Arm Phosphate Coating, Completely Electrostatic Powder Painted.
- Products are shipped with cardboard packaging after tested hundred percent.
- All Hose Connections are done with Special Press Method. Clamp etc. are never used.
- Recessed Handle Lock (Corrosion Resistant - Stainless)
- Manufactured of Stainless CrNi Material, Leaf Hinge System
- Warning Signs and Signs in ISO 7010 Standards on the Cover (Tear-Free and Nonfading)
- Cover is Red Electrostatic Powder Painted.
- Optional Design Options are available. (Suitable for customer requests)
- Optional, Completely Stainless CrNi Material Options are available.

CASE FOOT ROOF

- A1 Quality Manufactured from Galvanized Sheet Metal as One-Piece
- Case Design Suitable for Right and Left Handed Hose Baskets
- Reinforced, Hose Basket Carrier Console
- Case is Red Electrostatic Powder Painted.
- Optional Design Options are available. (Suitable for customer requests)
- Optional, Completely Stainless CrNi Material Options are available.
- Special Hydrant Cabinet Foot Manufactured from Box Profile
- Mounting Tabs Providing Foot Mounting on Concrete Floor
- Foot Phosphate Coating, Black Electrostatic Powder Painted.
- Optional Design Options are available. (Suitable for customer requests)
- Optional, Completely Stainless CrNi Material Options are available.
- A1 Quality Galvanized Sheet Metal Manufactured Roof
- Forward and Backward Sloping Roof Design
- Roof is Red Electrostatic Powder Painted.
- Optional Design Options are available. (Suitable for customer requests)
- Optional, Completely Stainless CrNi Material Options are available.

İÇ MALZEME

- Merkezinden Su Beslemeli, Makara, TS-EN 671-1/CE Belgeli
- Yuvarlak kesitli, Yarı Sert Yangın Hortumu, TS EN 694 Belgeli
- Vana ile Makara Merkezi Arasında Su Geçişini Sağlayan, Ara Bağlantı Hortumu
- 2" Yangın Vanası opsiyonel
- 2" İçten Dişli Rekor (Alüminyum- Storz Tip)
- 2" x 1" Redüksiyon (Alüminyum- Storz Tip)
- 5mm Sacdan İmal, Laser Kesim Makara Kolu (270° Makara Hareketi Sağlayan)
- Jet, Sprey ve Off Konumlarına Sahip UL-FM ve DIN / EN 671-1'e Uygun Nozul
- A1 Kalite Sacdan İmal, Makara TAMBURU
- Makara TAMBURU Üzeri Komple Elektrostatik Toz Boyalıdır. (Kırmızı)
- Makara Kolu Üzeri Komple Elektrostatik Toz Boyalıdır.
- Ürünler Yüzde Yüz Test Edildikten Sonra Karton Ambalaj ile Sevk Edilmektedir.
- Tüm Hortum Bağlantıları Özel Pres Baskı Yöntemi ile Yapılır. Asla Kelepçe vb. Kullanılmaz.
- Gömme Kollu Kilit (Korozyona Dayanıklı- Paslanmaz)
- Paslanmaz CrNi Malzemedan İmal, Yaprak Mentеше Sistemi
- Kapak Üzerinde ISO 7010 Standartlarında Uyarıcı Yazı ve İşaretler
- Kapak Kırmızı Elektrostatik Toz Boyalıdır.
- Opsiyonel Tasarım Seçenekleri Bulunmaktadır. (Müşteri İsteklerine Uygun)
- Opsiyonel Komple Paslanmaz CrNi Malzeme Seçenekleri Bulunmaktadır.

KASA-AYAK-ÇATI

- A1 Kalite Galvanizli Sacdan Tek Parça Olarak İmal Kasa
- Sağ ve Sol Kullanımlı Hortum Sepetlerine Uygun Kasa Tasarımı
- Kuvvetlendirilmiş, Hortum Sepeti Taşıyıcı Konsol
- Kasa Kırmızı Elektrostatik Toz Boyalıdır.
- Opsiyonel Tasarım Seçenekleri Bulunmaktadır. (Müşteri İsteklerine Uygun)
- Opsiyonel Komple Paslanmaz CrNi Malzeme Seçenekleri Bulunmaktadır.
- Kutu Profilinden Mamül Özel Hidrant Dolabı Ayağı
- Ayağın Beton Zemine Montajını Sağlayan Montaj Kulakçıkları
- Opsiyonel Tasarım Seçenekleri Bulunmaktadır. (Müşteri İsteklerine Uygun)
- Opsiyonel Komple Paslanmaz CrNi Malzeme Seçenekleri Bulunmaktadır.
- A1 Kalite Galvanizli Sacdan İmal Çatı
- Öne ve Arkaya Eğimli Çatı Tasarımı
- Çatı Kırmızı Elektrostatik Toz Boyalıdır.
- Opsiyonel Tasarım Seçenekleri Bulunmaktadır. (Müşteri İsteklerine Uygun)
- Opsiyonel Komple Paslanmaz CrNi Malzeme Seçenekleri Bulunmaktadır.



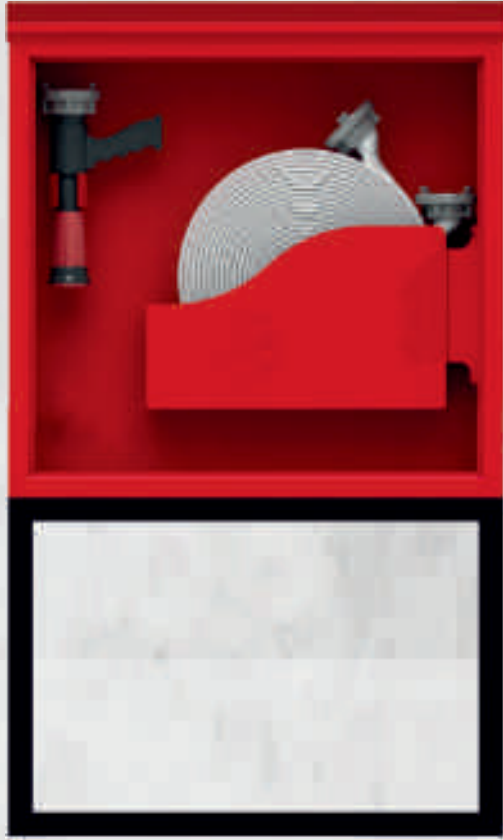

EK 520



EK 530

EK 520-530 SERIES FIRE HYDRANT CABINETS WITH LAY FLAT HOSE WITH 1 SET OF ACCESSORIES

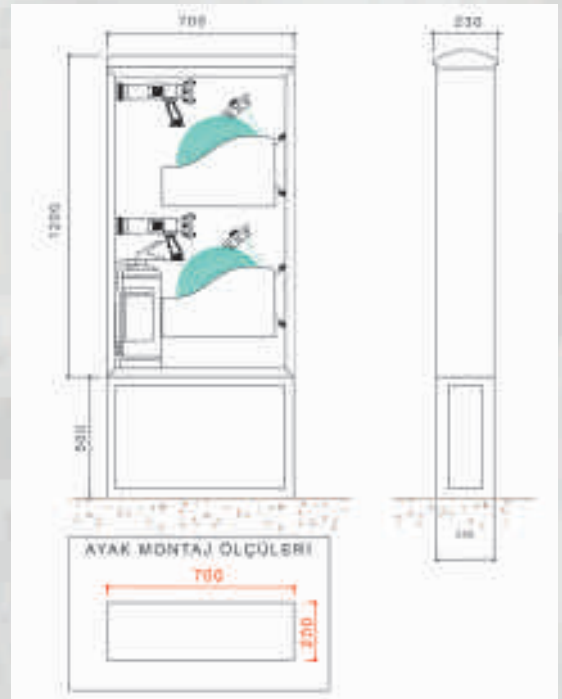
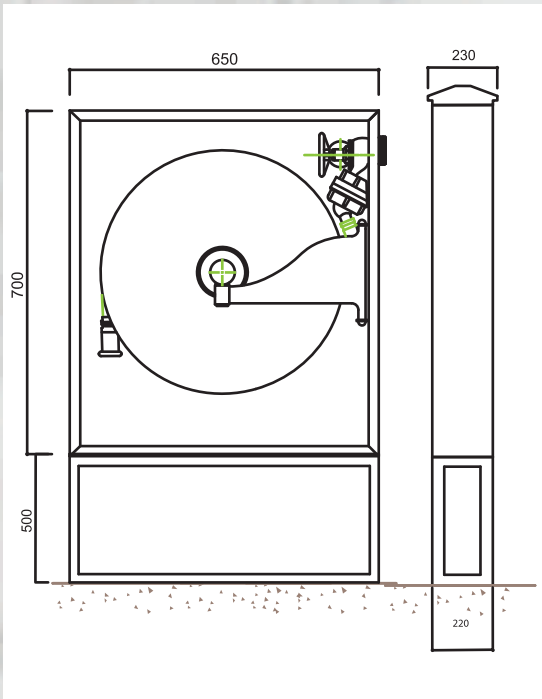

COVER OPTIONS

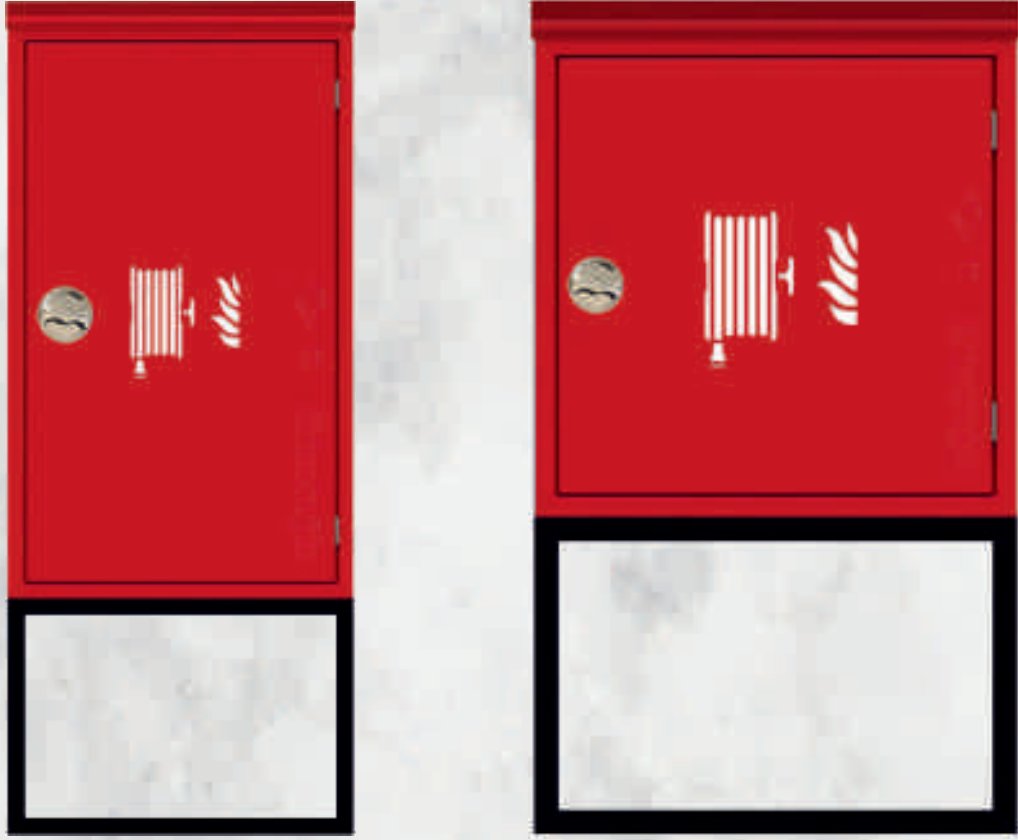

EK 520-530 SERIES

INTERNAL MATERIALS DISASSEMBLED COVER

- Water Supplied from Center, Corrosion Resistant Reel, TS-EN 671-1 / CE Certified
- Semi-Hard Fire Hose with round section, TS EN 694 Certificated
- Interconnection Hose (Unbreakable Type) Providing Water Passage between Valve and Reel Center
- 2" Fire Valve optional
- 2" Internal Threaded Union (Aluminum - Storz Type)
- 2"x 1" Reduction (Aluminum - Storz Type)
- 5mm Made of Sheet Metal, Laser Cut Reel Arm (Provides 270° Reel Movement)
- With Jet, Spray and Off positions and Nozzle according to UL-FM and DIN / EN 671-1
- A1 Quality Sheet Metal Production, Reel Rim
- Reel Rim Phosphate Coating, Completely Electrostatic Powder Painted, (Red)
- Reel Arm Phosphate Coating, Completely Electrostatic Powder Painted.
- Products are shipped with cardboard packaging after tested hundred percent.
- All Hose Connections are done with Special Press Method. Clamp etc. are never used.
- Recessed Handle Lock (Corrosion Resistant - Stainless)
- Manufactured of Stainless CrNi Material, Leaf Hinge System
- Warning Signs and Signs in ISO 7010 Standards on the Cover (Tear-Free and Nonfading)
- Cover is Red Electrostatic Powder Painted.
- Optional Design Options are available. (Suitable for customer requests)
- Optional, Completely Stainless CrNi Material Options are available.

CASE FOOT ROOF

- A1 Quality Manufactured from Galvanized Sheet Metal as One-Piece
- Case Design Suitable for Right and Left Handed Hose Baskets
- Reinforced, Hose Basket Carrier Console
- Case is Red Electrostatic Powder Painted.
- Optional Design Options are available. (Suitable for customer requests)
- Optional, Completely Stainless CrNi Material Options are available.
- Special Hydrant Cabinet Foot Manufactured from Box Profile
- Mounting Tabs Providing Foot Mounting on Concrete Floor
- Foot Phosphate Coating, Black Electrostatic Powder Painted.
- Optional Design Options are available. (Suitable for customer requests)
- Optional, Completely Stainless CrNi Material Options are available.
- A1 Quality Galvanized Sheet Metal Manufactured Roof
- Forward and Backward Sloping Roof Design
- Roof is Red Electrostatic Powder Painted.
- Optional Design Options are available. (Suitable for customer requests)
- Optional, Completely Stainless CrNi Material Options are available.

İÇ MALZEME

- Merkezinden Su Beslemeli, Makara, TS-EN 671-1/CE Belgeli
- Yuvarlak kesitli, Yarı Sert Yangın Hortumu, TS EN 694 Belgeli
- Vana ile Makara Merkezi Arasında Su Geçişini Sağlayan, Ara Bağlantı Hortumu
- 2" Yangın Vanası opsiyonel
- 2" İçten Dişli Rekor (Alüminyum - Storz Tip)
- 2" x 1" Redüksiyon (Alüminyum- Storz Tip)
- 5mm Sacdan İmal, Laser Kesim Makara Kolu (270° Makara Hareketi Sağlayan)
- Jet, Sprey ve Off Konumlarına Sahip UL-FM ve DIN / EN 671-1'e Uygun Nozul
- A1 Kalite Sacdan İmal, Makara TAMBURU
- Makara TAMBURU Üzeri Komple Elektrotatik Toz Boyalıdır. (Kırmızı)
- Makara Kolu Üzeri Komple Elektrotatik Toz Boyalıdır.
- Ürünler Yüzde Yüz Test Edildikten Sonra Karton Ambalaj ile Sevk Edilmektedir.
- Tüm Hortum Bağlantıları Özel Pres Baskı Yöntemi ile Yapılır. Asla Kelepçe vb. Kullanılmaz.
- Gömme Kollu Kilit (Korozyona Dayanıklı- Paslanmaz)
- Paslanmaz CrNi Malzemedan İmal, Yaprak Mentеше Sistemi
- Kapak Üzerinde ISO 7010 Standartlarında Uyarıcı Yazı ve İşaretler
- Kapak Kırmızı Elektrotatik Toz Boyalıdır.
- Opsiyonel Tasarım Seçenekleri Bulunmaktadır. (Müşteri İsteklerine Uygun)
- Opsiyonel Komple Paslanmaz CrNi Malzeme Seçenekleri Bulunmaktadır.

KASA-AYAK-ÇATI

- A1 Kalite Galvanizli Sacdan Tek Parça Olarak İmal Kasa
- Sağ ve Sol Kullanımlı Hortum Sepetlerine Uygun Kasa Tasarımı
- Kuvvetlendirilmiş, Hortum Sepeti Taşıyıcı Konsol
- Kasa Kırmızı Elektrotatik Toz Boyalıdır.
- Opsiyonel Tasarım Seçenekleri Bulunmaktadır. (Müşteri İsteklerine Uygun)
- Opsiyonel Komple Paslanmaz CrNi Malzeme Seçenekleri Bulunmaktadır.
- Kutu Profilden Mamül Özel Hidrant Dolabı Ayağı
- Ayağın Beton Zemine Montajını Sağlayan Montaj Kulakçıkları
- Opsiyonel Tasarım Seçenekleri Bulunmaktadır. (Müşteri İsteklerine Uygun)
- Opsiyonel Komple Paslanmaz CrNi Malzeme Seçenekleri Bulunmaktadır.
- A1 Kalite Galvanizli Sacdan İmal Çatı
- Öne ve Arkaya Eğimli Çatı Tasarımı
- Çatı Kırmızı Elektrotatik Toz Boyalıdır.
- Opsiyonel Tasarım Seçenekleri Bulunmaktadır. (Müşteri İsteklerine Uygun)
- Opsiyonel Komple Paslanmaz CrNi Malzeme Seçenekleri Bulunmaktadır.





A SERIES ONE DOOR FIRE CABINETS WITH SEMI RIGID HOSE - WITH FIRE EXTINGUISHER HELD VERTICAL

RECESSED TYPE

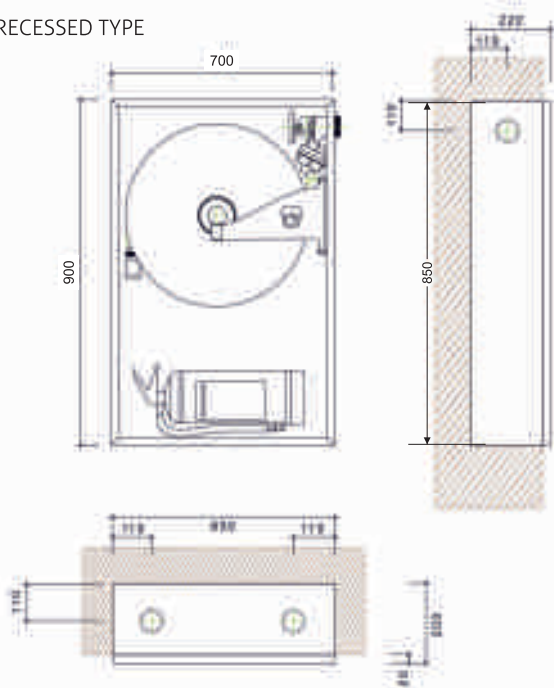

SURFACE MOUNTED TYPE
700

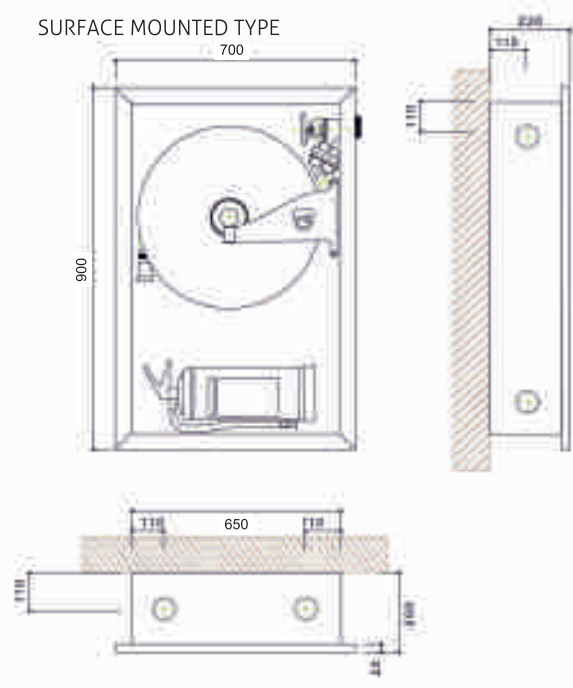

COVER OPTIONS

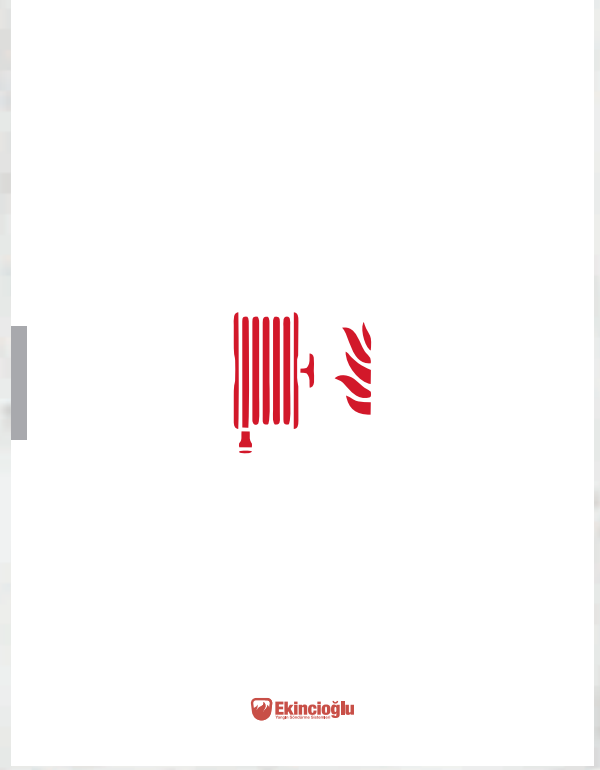
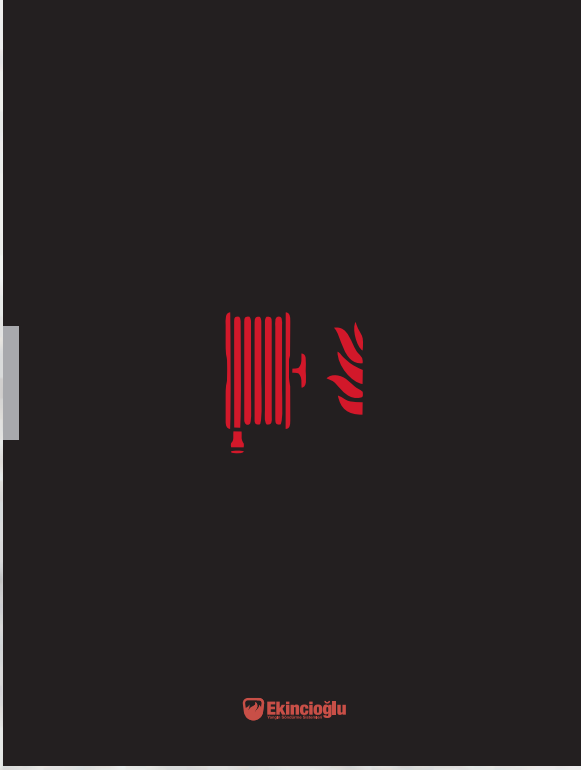

A-SERIES

TECHNICAL SPECIFICATIONS

- Water Supplied from Center, Corrosion Resistant Reel, TS-EN 671-1 / CE Certified
- Semi-Hard Fire Hose with round section, TS EN 694 Certificated
- Interconnection Hose (Unbreakable Type) Providing Water Passage between Valve and Reel Center
- 2" Fire Valve
- 2" Internal Threaded Union
- 2"x 1" Reduction
- 5mm Made of Sheet Metal, Laser Cut Reel Arm (Provides 270° Reel Movement)
- With Jet, Spray and Off positions and Nozzle according to UL-FM and DIN / EN 671-1
- A1 Quality Sheet Metal Production, Reel Rim
- Reel Rim Phosphate Coating, Completely Electrostatic Powder Painted. (Red)
- Reel Arm Phosphate Coating, Completely Electrostatic Powder Painted. (Black)
- Products are shipped with cardboard packaging after tested hundred percent.
- All Hose Connections are done with Special Press Method. Clamp etc. are never used.
- All hose Connections are covered with plastic to prevent the damage to user.

DISASSEMBLED COVER- Mounted Case

- A1 Quality Sheet Metal Production, Disassembled Sheet Metal or Glass Cover
- Recessed Handle (Corrosion Resistant - Stainless)
- 180° Openable, Recessed-Hidden Hinge System (Corrosion Resistant - Stainless)
- 4mm, Smoked Color or Black Painted Tempered Glass on Glass Covers
- Warning Signs and Signs in ISO Standards on the Cover (Tear-Free and Nonfading)
- Cover Phosphate Coating with Red or White Electrostatic Powder Painted.
- * Optional Color and Design Options (Ral Codes for customer requests)
- A1 Quality Manufactured as a single piece of sheet metal, Recessed or Surface
- Breakable Valve Connection Caps on Side, Top and Back Surfaces of the Case
- Case Design Suitable for Right and Left Handed Reels
- Case Phosphate Coating with Red or White Electrostatic Powder Painted.
- Optional Color and Design Options (Ral Codes for customer requests)
- Optional, Completely Stainless CrNi Material Options are available.
- Tear-proof, Nonfading, PVC Operating Instructions are available on the Case.

TEKNİK ÖZELLİKLERİ

- Merkezinden Su Beslemeli, Korozyona Dayanıklı Makara, TS-EN 671-1/CE Belgeli
- Yuvarlak kesitli, Yarı Sert Yangın Hortumu, TS EN 694 Belgeli
- Vana ile Makara Merkezi Arasında Su Geçişini Sağlayan, Ara Bağlantı Hortumu
- 2" Yangın Vanası
- 2" İçten Dişli Rekor
- 2" x 1" Redüksiyon
- 5mm Sacdan İmal, Lazer Kesim Makara Kolu (270°Makara Hareketi Sağlayan)
- Jet, Sprey ve Off Konumlarına Sahip UL-FM ve DIN / EN 671-1'e Uygun Nozul
- A1 Kalite Sacdan İmal, Makara Jantı
- Makara Jantı Üzeri Komple Elektrostatik Toz Boyalıdır. (Kırmızı RAL3002)
- Makara Kolu Üzeri Komple Elektrostatik Toz Boyalıdır. (KIRMIZI RAL3002)
- Ürünler Yüzde Yüz Test Edildikten Sonra Karton Ambalaj ile Sevk Edilmektedir.
- Tüm Hortum Bağlantıları Özel Pres Baskı Yöntemi ile Yapılır. Asla Kelepçe vb. Kullanılmaz.
- Tüm Hortum Bağlantıları Plastik ile Kaplanarak Kullanıcıya Zarar Vermesi Önlenmiştir.

KAPAK- KASA ÖZELLİKLERİ

- A1 Kalite Sacdan İmal, Sac veya Cam Kapak
- Gömme Kulüp (Paslanmaz)
- 180° Açılır, Gömme-Gizli Menteşe Sistemi (Paslanmaz)
- Cam Kapaklarda 4mm, Füme Renkli veya Siyah Boyalı Temperli Cam
- Kapak Üzerinde ISO Standartlarında Uyuncu Yazı ve İşaretler
- Kapak Üzeri Kırmızı veya Beyaz Elektrostatik Toz Boyalıdır.
- Opsiyonel Renk ve Tasarım Seçenekleri (Müşteri İsteklerine uygun Ral Kodlarında)
- A1 Kalite Sacdan Tek Parça Olarak İmal, Gömme veya Sivaüstü Kasa
- Kasanın Yan, Üst ve Arka Yüzeylerinde Kırılabilir Vana Bağlantı Kapakları
- Sağ ve Sol Kullanımlı Makaralara Uygun Kasa Tasarımı
- Kasa Üzeri Kırmızı veya Beyaz Elektrostatik Toz Boyalıdır.
- Opsiyonel Renk ve Tasarım Seçenekleri (Müşteri İsteklerine Uygun Ral Kodlarında)
- Opsiyonel Komple Paslanmaz CrNi Malzeme Seçenekleri Bulunmaktadır.
- Kasa Üzerinde Pvc Malzemeden İmal, Yırtılmaz Kullanma Talimatı Bulunmaktadır.





EK 600 SERİSİ FOAM CABINETS WITH SEMI-RIGID HOSE
WITH 40LT FOAM CAPACITY

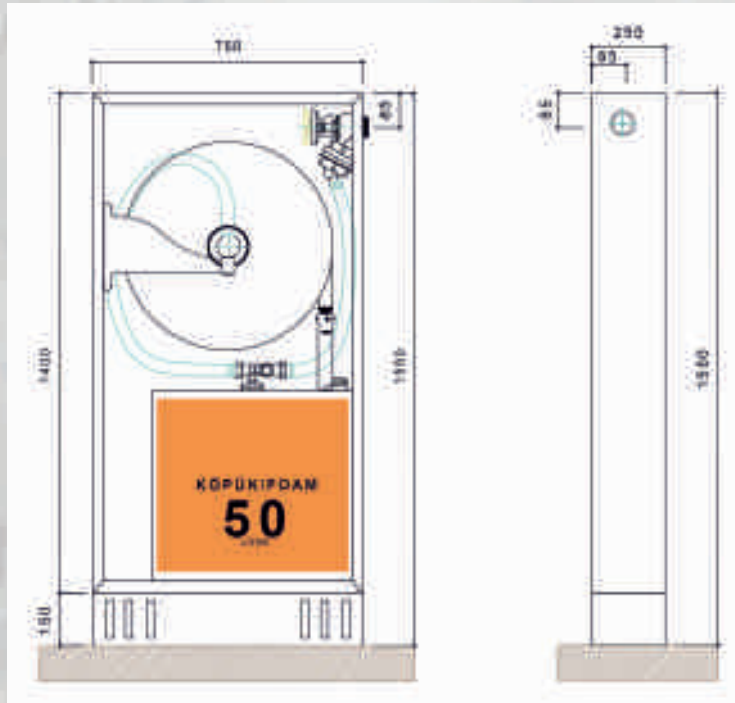

COVER OPTIONS



EK 600 D1



EK 600 D2

EK 600 SERIES

INTERNAL MATERIALS

- Water Supplied from Center, Corrosion Resistant Reel, TS-EN 671-1 / CE Certified
- Semi-Hard Fire Hose with round section, TS EN 694 Certificated
- 2" Fire Valve optional
- 2" Internal Threaded Union (Aluminum - Storz Type)
- 2"x 1" Reduction (Aluminum - Storz Type)
- 5mm Made of Sheet Metal, Laser Cut Reel Arm (Provides 270° Reel Movement)
- A1 Quality Sheet Metal Production, Reel Rim
- Reel Rim Phosphate Coating, Completely Electrostatic Powder Painted. (Red)
- Reel Arm Phosphate Coating, Completely Electrostatic Powder Painted. (Black)
- 1" Foam Mixer (100 l / min.), Stainless, Water-Foam Ratio 1% - 3% - 6%, TS EN 13565-1 + A1
- 1" Controlled Foam Lance (On-Off), Stainless, TS EN13565-1 + A1
- Special Foam Tank with 40lt Capacity and Resistant to Chemical Structure of Foam
- Products are shipped with cardboard packaging after tested hundred percent.
- All Hose Connections are done with Special Press Method. Clamp etc. are never used.

Foam Fire Cabinets provide the opportunity to intervene in fires that may occur in volumes where the water extinguishing effect has not been sufficiently observed or the substances that can react with water are stored and produced. Examples of areas of use include Factories, Industrial Plants, Aircraft and Helicopter Hangars, Parking lots and Gas Stations. Foam Fire Cabinets are suitable for Interventions with only water depending on water source other than Foam Intervention Period.

CASE DISASSEMBLED COVER BASE

- A1 Quality Manufactured as a single piece of sheet metal Surface Mounted Case
- Case Phosphate Coating with Red or White Electrostatic Powder Painted.
- Optional Color and Design Options (Ral Codes for customer requests)
- Optional, Completely Galvanized or Completely Stainless CrNi Material Options are available.
- A1 Quality Sheet Metal Production, Disassembled Sheet Metal or Glass Cover
- Manufactured of Stainless CrNi Material, Recessed Handle
- Manufactured of Stainless CrNi Material, Leaf Hinge System
- 4mm, Smoked Color Tempered Glass
- Warning Signs and Signs in ISO 7010 Standards on the Cover (Tear-Free and Nonfading)
- Cover Phosphate Coating with Red or White Electrostatic Powder Painted.
- Optional Color and Design Options (Ral Codes for customer requests)
- Optional, Completely Galvanized or Completely Stainless CrNi Material Options are available.
- A1 Quality Sheet Metal Manufactured Base
- Ventilation holes on the front and rear surfaces of the base
- Foot Phosphate Coating, Black Electrostatic Powder Painted.
- Optional, Completely Galvanized or Completely Stainless CrNi Material Options are available

İÇ MALZEME

- Merkezinden Su Beslemeli, Makara, TS-EN 671-1/CE Belgeli
- Yuvarlak kesitli, Yarı Sert Yangın Hortumu, TS EN 694 Belgeli
- 2" Yangın Vanası opsiyonel
- Merkezinden Su Beslemeli, Makara, TS-EN 671-1/CE Belgeli
- Yuvarlak kesitli, Yarı Sert Yangın Hortumu, TS EN 694 Belgeli
- 2" İçten Dişli Rekor (Alüminyum-Storz Tip)
- 2" x 1" Redüksiyon (Alüminyum-Storz Tip)
- 5mm Sacdan İmal, Lazer Kesim Makara Kolu (270° Makara Hareketi Sağlayan)
- A1 Kalite Sacdan İmal, Makara TAMBURU
- Makara TAMBURU Üzeri Komple Elektrostatik Toz Boyalıdır. (Kırmızı)
- Makara Kolu Üzeri Komple Elektrostatik Toz Boyalıdır.
- 1" Köpük Mikseri (100lt/dak.), Paslanmaz, Su-Köpük Oranı %1- %3- %6, TS EN 13565-1+A1
- 1" Kumandalı Köpük Lansı (On-Off), Paslanmaz, TS EN13565-1+A1
- 40lt Kapasiteli ve Köpüğün Kimyasal Yapısına Dayanıklı Özel Köpük Tankı
- Ürünler Yüzde Yüz Test Edildikten Sonra Karton Ambalajı ile Sevk Edilmektedir.
- Tüm Hortum Bağlantıları Özel Pres Baskı Yöntemi ile Yapılır.

Köpüklü Yangın Dolapları Suyun Söndürme Etkisinin Yeterli Görülmediği veya Su ile Reaksiyona Girebilecek Maddelerin Bulunduğu, Depolandığı ve Ürettiği Hacimlerde Meydana Gelebilecek Yangınlara Müdahale İmkânı Sağlar. Kullanım Alanlarına Örnek Olarak Fabrikalar, Endüstriyel Tesisler, Uçak ve Helikopter Hangarları, Otopark ve Benzin İstasyonları Gibi Yerler Gösterilebilir. Köpüklü Yangın Dolapları Köpüklü Müdahale Süresinin Dışında Su Kaynağına Bağlı Olarak Sadece Su ile Müdahalelere de Uygundur.

KASA VE AYAK

- A1 Kalite Sacdan Tek Parça Olarak İmal Sıvaüstü Kasa
- Kasa Üzeri Kırmızı Elektrostatik Toz Boyalıdır.
- Opsiyonel Tasarım Seçenekleri Bulunmaktadır. (Müşteri İsteklerine Uygun)
- Opsiyonel, Komple Galvanizli veya Komple Paslanmaz CrNi Malzeme Seçenekleri Bulunmaktadır.
- A1 Kalite Sacdan İmal, Sac veya Cam Kapak
- Paslanmaz CrNi Malzemeden İmal, Gömme Kulp
- Paslanmaz CrNi Malzemeden İmal, Yaprak Menteşe Sistemi
- 4mm, Fıme Renkli, Temperli Cam
- Kapak Üzerinde ISO 7010 Standartlarında Uyarıcı Yazı ve İşaretler (Yırtılmaz-Solmaz Yapıda)
- Kapak Üzeri Kırmızı Elektrostatik Toz Boyalıdır.
- Opsiyonel Tasarım Seçenekleri Bulunmaktadır. (Müşteri İsteklerine Uygun)
- Opsiyonel, Komple Galvanizli veya Komple Paslanmaz CrNi Malzeme Seçenekleri Bulunmaktadır.
- A1 Kalite Sacdan İmal AYAK
- Ayak Ön ve Arka Yüzeylerinde Bulunan Havalandırma Delikleri
- Ayak Siyah Elektrostatik Toz Boyalıdır.
- Opsiyonel, Komple Galvanizli veya Komple Paslanmaz CrNi Malzeme Seçenekleri Bulunmaktadır. , TS 12259 Belgeli





EK 700 SERIES 20/25/30 M

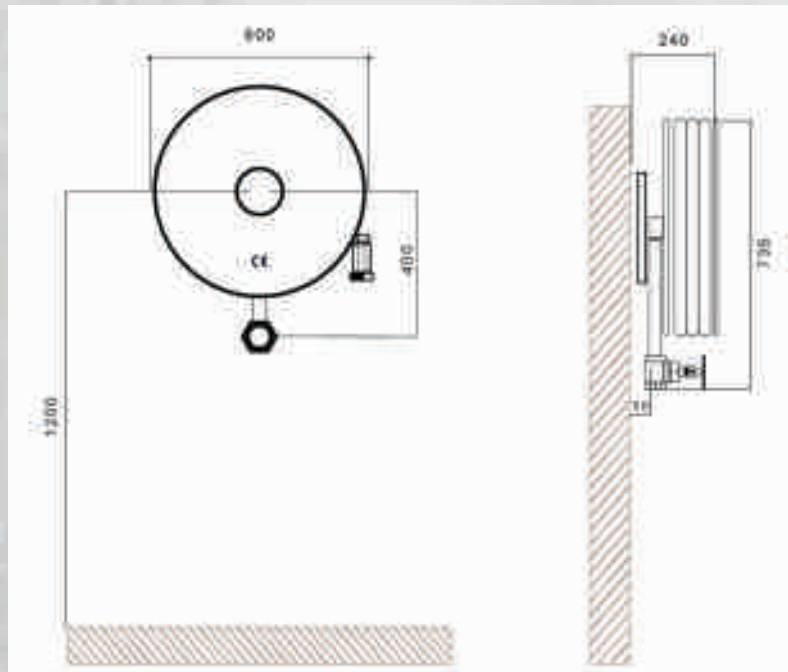



40/50/60 M

EK 800 SERIES FIRE HOSE TROLLEY WITH SEMI-RIGID HOSE

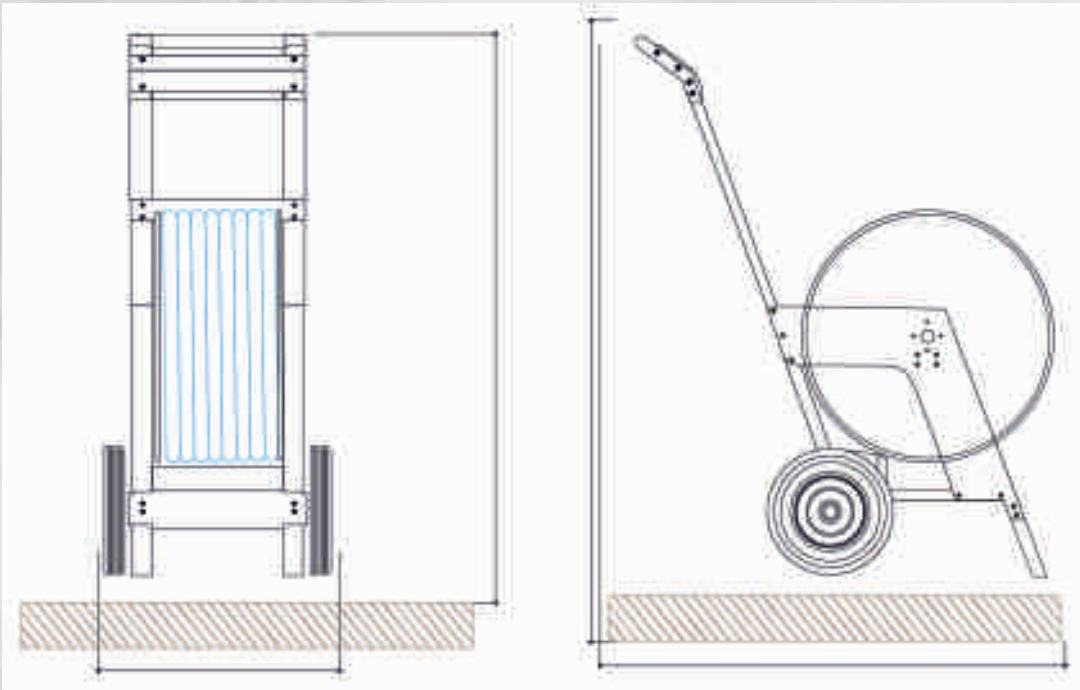



EK 900



EK 920

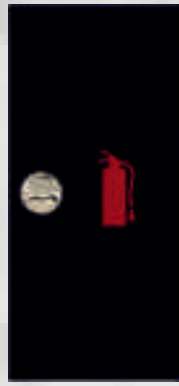
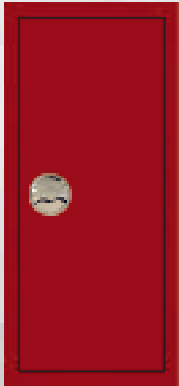

EK 900 - 920 SERIES FIRE EXTINGUISHER CABINETS

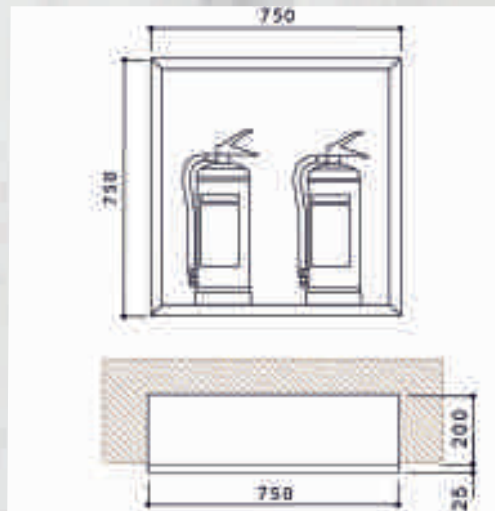
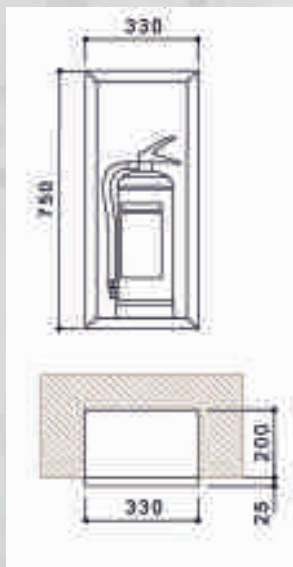



FIRE FIGHTING EQUIPMENT CABINETS

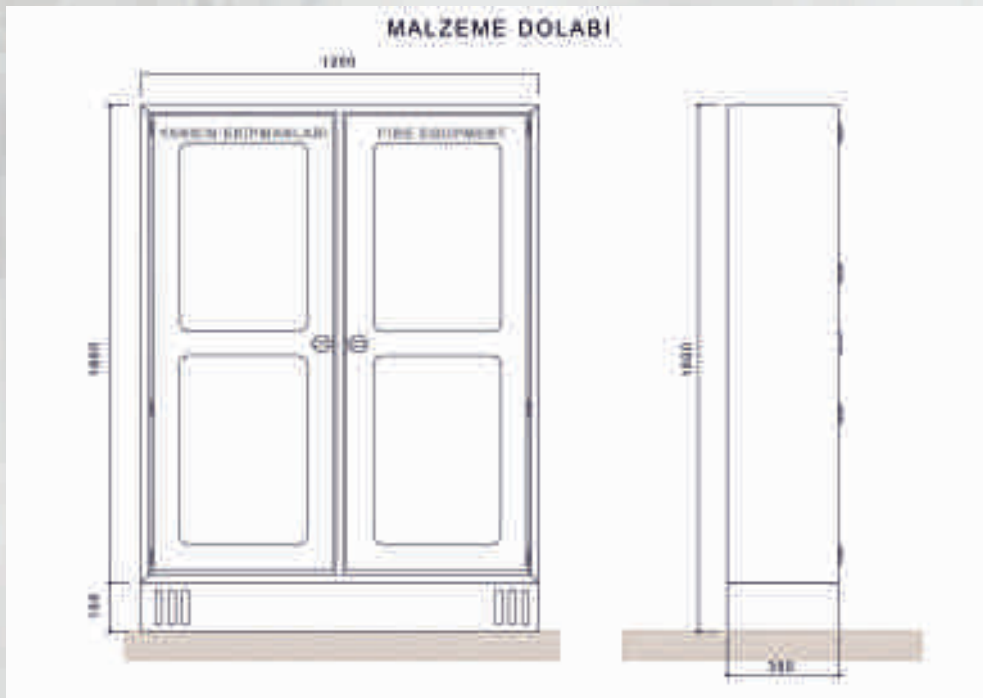

Special Products

EK- 1001



EK- 1002



EK- 1003

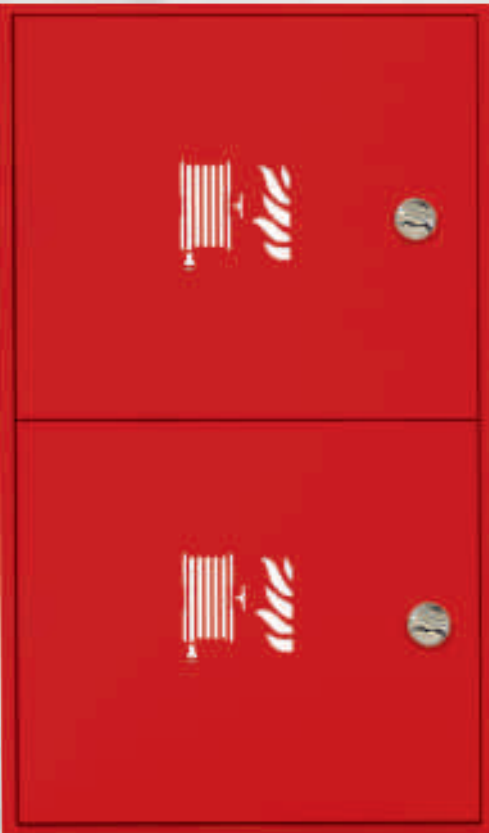

Yangın Kapıları / Fire Doors



Tek Kanatlı Yangın Kapısı
Single Wing Fire Door



Standart: 100x210 cm

Single Wing Fire Door
Double Wing Fire Door



Standart: 150x210 cm
Özel: 130x210 cm - Özel: 140x210 cm

SHAFT COVER / COLLECTOR CABINET 40x60 - 60x60 - 80x60





WITH LAY FLAT HOSE



1" SEMI-RIGID HOSE



WITH LAY FLAT HOSE

KISA TRİFONLU KELEPÇE



Ölçü	Ölçü	Sıkma Aralığı
AKTK020	1/2"	20-24
AKTK025	3/4"	25-28
AKTKK032	1"	32-38
AKTK040	1 1/4"	39-46
AKTK050	1 1/2"	48-53
AKTK063	2"	56-66
AKTK075	2 1/2"	74-80
AKTK090	3"	87-94
AKTK110	4"	110-116
AKTK125	4 1/2"	120-128
AKTK140	5"	135-143
AKTK165	6"	162-170

FIRE VALVES / SPRINGS



2 " SHUT-OFF VALVE



2 " REDUCING VALVE



FIRE PORT
4X2,5X2,5 - 4X2-2-2,5X2,5X2,5



1 " BALL VALVE



PENDENT SPRINK



UPRIGHT SPRINK



SIDEWALL SPRINKLER

FIRE HIDRANTS



FIRE EXTINGUISHER



1 KG FIRE EXTINGUISHER



6 KG FIRE EXTINGUISHER



50 KG FIRE EXTINGUISHER

STANDART SOMUNLU KELEPÇE



Ölçü	Ölçü	Sıkma Aralığı
ASSK020	1/2"	20-24
ASSK025	3/4"	25-28
ASSK032	1"	32-38
ASSK040	1 1/4"	39-46
ASSK050	1 1/2"	48-53
ASSK063	2"	56-66
ASSK075	2 1/2"	74-80
ASSK090	3"	87-94
ASSK110	4"	110-116
ASSK125	4 1/2"	120-128
ASSK140	5"	135-143
ASSK165	6"	162-170
ASSK200	7"	198-207
ASSK210	8"	207-219

FIRE EQUIPMENT



FIRE BUTTON



FIRE ALARM



SMOKE DETECTOR



STANDS

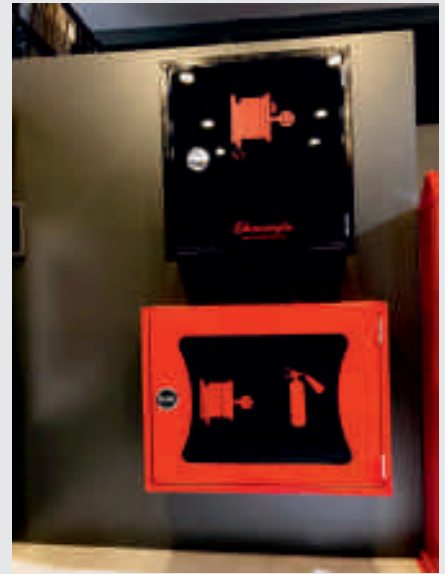



Ekincioglu

Yangın Söndürme Sistemleri

EKİNCİOĞLU YANGIN SÖNDÜRME SİSTEMLERİ
DANIŞ. İNŞ. TAAH. TARIM HAYV. OTOM. SAN. VE TİC. LTD. ŞTİ.

30 Ağustos Mah. Seda Sk. No:15/A Melikgazi / KAYSERİ

Tel-Fax: +90.352 327 45 14

GSM: + 90 532 718 18 38 - + 90 533 399 93 98

www.ekinciogluyangin.com

info@ekinciogluyangin.com • export@ekinciogluyangin.com

